



# PRODUCT ASSEMBLY INSTRUCTIONS:

[www.wavearmor.com](http://www.wavearmor.com)

**Item # | Product Name:** #302345 Pontoon Port 2" Post Attachment Kit

Parts List:	Tools Needed:
1. Plastic Post Attachment Top and Base qty 2 each	1. Ratchet with short extension and 9/16" socket
2. 3/8 x 1 1/2" bolt qty 12, 3/8" lock washer qty 12, 3/8" heavy washer qty 12	2. Hammer or Mallet
3.	3.
4.	4.
5.	5.
6.	6.
7.	7.

**Assembly Instructions: (2" Post Attachment shown, 3" and 4" installation is the same.)**

1. Slide post attachment base into the opening on the pontoon port as shown below. It will be easier to install this before putting the port into the water. Tap it into place if necessary.

Slide base up into position.

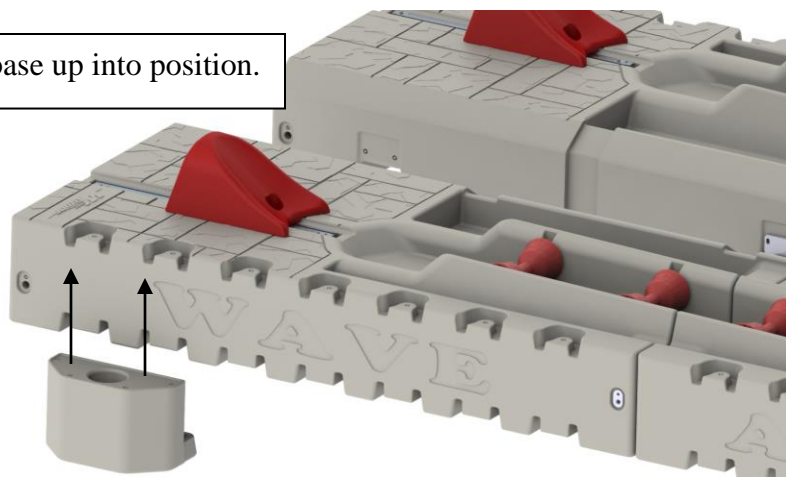

Base in position.

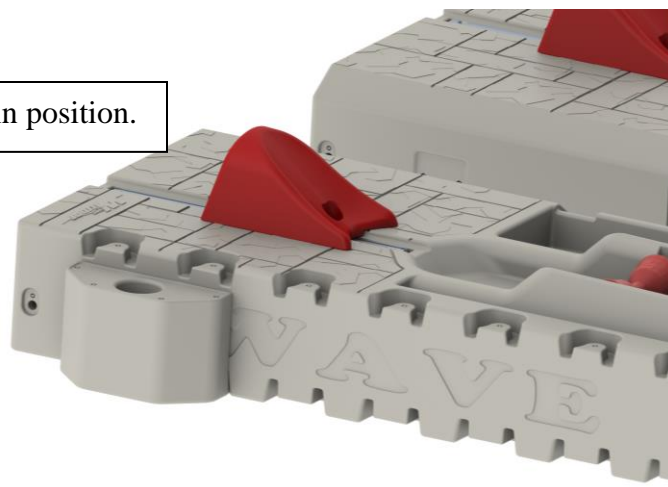

2. Install post attachment top onto the post attachment base as shown below. Thread the 3/8 x 1 1/2" bolts, lock washers and heavy washers into the top of the post attachment in six places. Tighten securely. Repeat on other side of pontoon port.

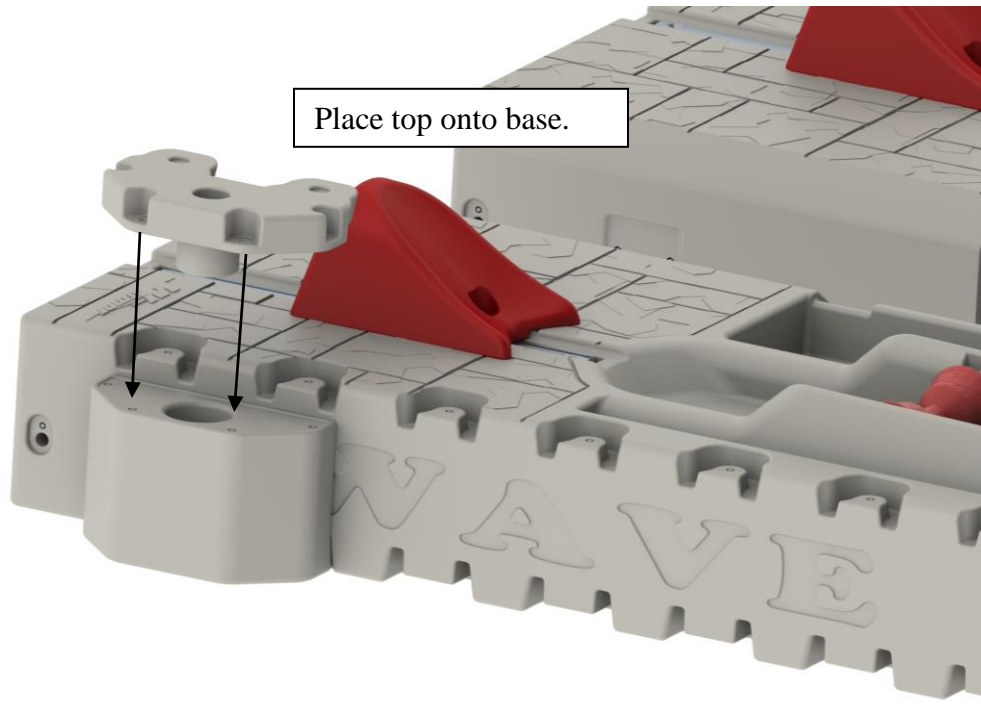

Secure top with the 3/8 x 1 1/2" bolts and washers in six places.

